

EMX2DXV6T5

Preferred Devices

Dual NPN General Purpose Amplifier Transistor

This NPN transistor is designed for general purpose amplifier applications. This device is housed in the SOT-563 package which is designed for low power surface mount applications, where board space is at a premium.

Features

- Reduces Board Space
- High h_{FE} , 210–460 (Typical)
- Low $V_{CE(sat)}$, < 0.5 V
- These are Pb-Free Devices

MAXIMUM RATINGS ($T_A = 25^\circ\text{C}$)

Rating	Symbol	Value	Unit
Collector-Base Voltage	$V_{(BR)CBO}$	60	Vdc
Collector-Emitter Voltage	$V_{(BR)CEO}$	50	Vdc
Emitter-Base Voltage	$V_{(BR)EBO}$	7.0	Vdc
Collector Current – Continuous	I_C	100	mAdc

THERMAL CHARACTERISTICS

Characteristic (One Junction Heated)	Symbol	Max	Unit
Total Device Dissipation $T_A = 25^\circ\text{C}$ Derate above 25°C	P_D	357 (Note 1) 2.9 (Note 1)	mW mW/ $^\circ\text{C}$
Thermal Resistance, Junction-to-Ambient	$R_{\theta JA}$	350 (Note 1)	$^\circ\text{C}/\text{W}$
Characteristic (Both Junctions Heated)	Symbol	Max	Unit
Total Device Dissipation $T_A = 25^\circ\text{C}$ Derate above 25°C	P_D	500 (Note 1) 4.0 (Note 1)	mW mW/ $^\circ\text{C}$
Thermal Resistance, Junction-to-Ambient	$R_{\theta JA}$	250 (Note 1)	$^\circ\text{C}/\text{W}$
Junction and Storage Temperature Range	T_J, T_{stg}	-55 to +150	$^\circ\text{C}$

Maximum ratings are those values beyond which device damage can occur. Maximum ratings applied to the device are individual stress limit values (not normal operating conditions) and are not valid simultaneously. If these limits are exceeded, device functional operation is not implied, damage may occur and reliability may be affected.

1. FR-4 @ Minimum Pad



ON Semiconductor®

<http://onsemi.com>

DUAL NPN GENERAL PURPOSE AMPLIFIER TRANSISTORS SURFACE MOUNT

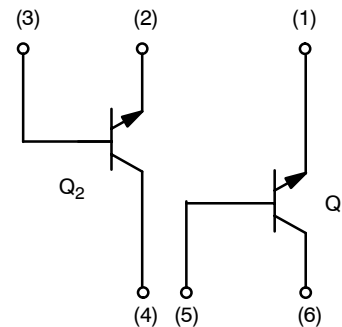

MARKING DIAGRAM

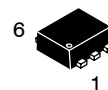

SOT-563
CASE 463A
STYLE 2

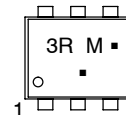

3R = Specific Device Code

M = Month Code

▪ = Pb-Free Package

(Note: Microdot may be in either location)

ORDERING INFORMATION

Device	Package	Shipping†
EMX2DXV6T5	SOT-563 (Pb-Free)	8000/Tape & Reel
EMX2DXV6T5G	SOT-563 (Pb-Free)	8000/Tape & Reel

†For information on tape and reel specifications, including part orientation and tape sizes, please refer to our Tape and Reel Packaging Specifications Brochure, BRD8011/D.

EMX2DXV6T5

ELECTRICAL CHARACTERISTICS ($T_A = 25^\circ\text{C}$)

Characteristic	Symbol	Min	Typ	Max	Unit
Collector-Base Breakdown Voltage ($I_C = 50 \mu\text{Adc}$, $I_E = 0$)	$V_{(BR)CBO}$	60	-	-	Vdc
Collector-Emitter Breakdown Voltage ($I_C = 1.0 \text{ mAdc}$, $I_B = 0$)	$V_{(BR)CEO}$	50	-	-	Vdc
Emitter-Base Breakdown Voltage ($I_E = 50 \mu\text{Adc}$, $I_C = 0$)	$V_{(BR)EBO}$	7.0	-	-	Vdc
Collector-Base Cutoff Current ($V_{CB} = 60 \text{ Vdc}$, $I_E = 0$)	I_{CBO}	-	-	0.5	μA
Emitter-Base Cutoff Current ($V_{EB} = 7.0 \text{ Vdc}$, $I_B = 0$)	I_{EBO}	-	-	0.5	μA
Collector-Emitter Saturation Voltage (Note 2) ($I_C = 50 \text{ mAdc}$, $I_B = 5.0 \text{ mAdc}$)	$V_{CE(sat)}$	-	-	0.4	Vdc
DC Current Gain (Note 3) ($V_{CE} = 6.0 \text{ Vdc}$, $I_C = 1.0 \text{ mAdc}$)	h_{FE}	120	-	560	-
Transition Frequency ($V_{CE} = 12 \text{ Vdc}$, $I_C = 2.0 \text{ mAdc}$, $f = 30 \text{ MHz}$)	f_T	-	180	-	MHz
Output Capacitance ($V_{CB} = 12 \text{ Vdc}$, $I_C = 0 \text{ Adc}$, $f = 1 \text{ MHz}$)	C_{OB}	-	2.0	-	pF

2. Device mounted on a FR-4 glass epoxy printed circuit board using the minimum recommended footprint.

3. Pulse Test: Pulse Width $\leq 300 \mu\text{s}$, D.C. $\leq 2\%$.

EMX2DXV6T5

TYPICAL ELECTRICAL CHARACTERISTICS

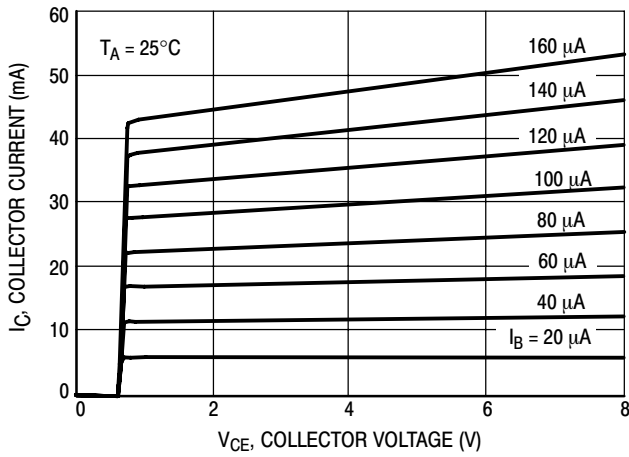

Figure 1. $I_C - V_{CE}$

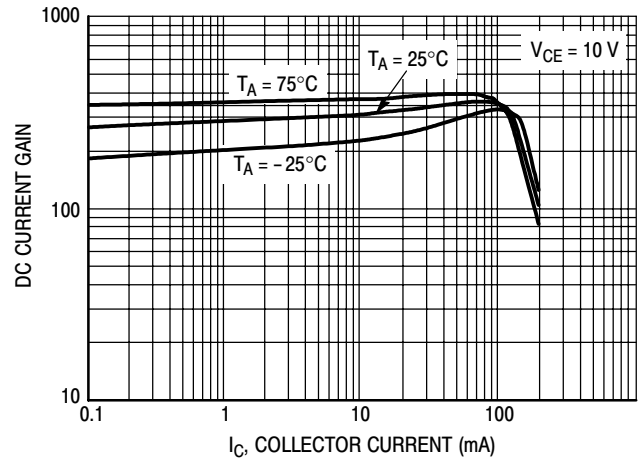

Figure 2. DC Current Gain

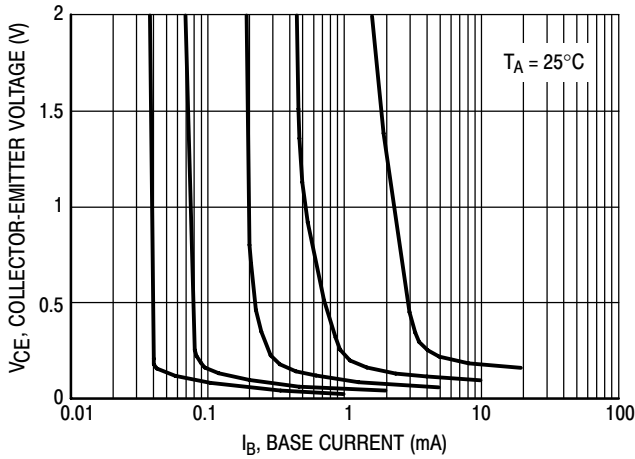

Figure 3. Collector Saturation Region

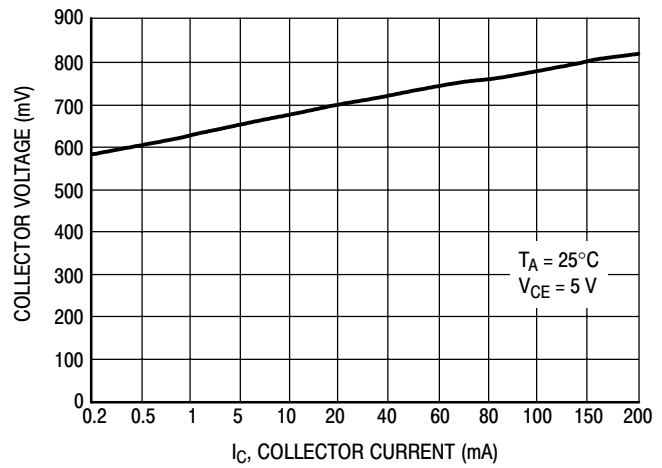

Figure 4. On Voltage

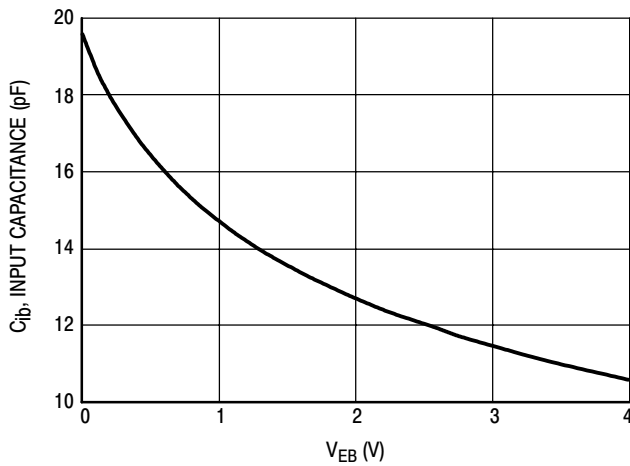

Figure 5. Capacitance

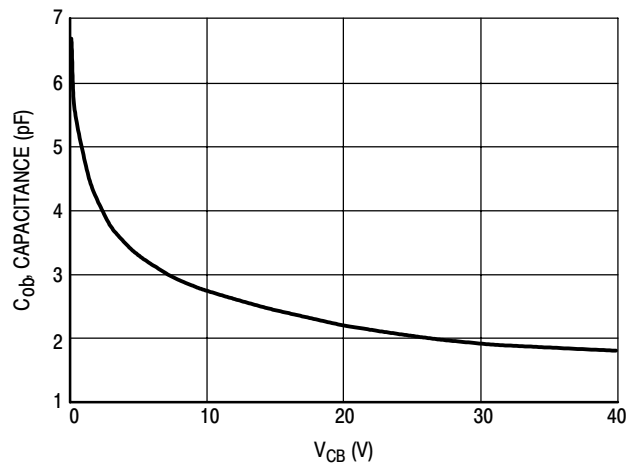
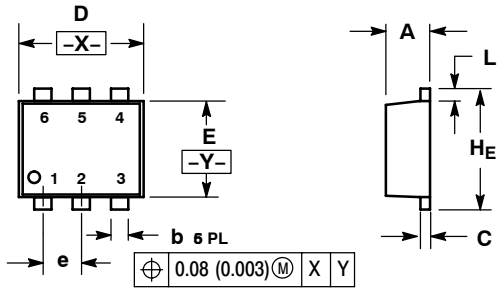

Figure 6. Capacitance

EMX2DXV6T5

PACKAGE DIMENSIONS

SOT-563, 6 LEAD
CASE 463A-01
ISSUE F



NOTES:

1. DIMENSIONING AND TOLERANCING PER ANSI Y14.5M, 1982.
2. CONTROLLING DIMENSION: MILLIMETERS
3. MAXIMUM LEAD THICKNESS INCLUDES LEAD FINISH THICKNESS. MINIMUM LEAD THICKNESS IS THE MINIMUM THICKNESS OF BASE MATERIAL.

DIM	MILLIMETERS			INCHES		
	MIN	NOM	MAX	MIN	NOM	MAX
A	0.50	0.55	0.60	0.020	0.021	0.023
b	0.17	0.22	0.27	0.007	0.009	0.011
C	0.08	0.12	0.18	0.003	0.005	0.007
D	1.50	1.60	1.70	0.059	0.062	0.066
E	1.10	1.20	1.30	0.043	0.047	0.051
e	0.5 BSC			0.02 BSC		
L	0.10	0.20	0.30	0.004	0.008	0.012
H _E	1.50	1.60	1.70	0.059	0.062	0.066

STYLE 2:

1. EMITTER 1
2. EMITTER 2
3. BASE 2
4. COLLECTOR 2
5. BASE 1
6. COLLECTOR 1

SOLDERING FOOTPRINT*

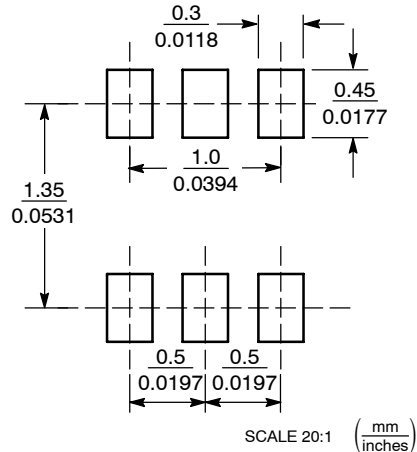

*For additional information on our Pb-Free strategy and soldering details, please download the ON Semiconductor Soldering and Mounting Techniques Reference Manual, SOLDERRM/D.

ON Semiconductor and are registered trademarks of Semiconductor Components Industries, LLC (SCILLC). SCILLC reserves the right to make changes without further notice to any products herein. SCILLC makes no warranty, representation or guarantee regarding the suitability of its products for any particular purpose, nor does SCILLC assume any liability arising out of the application or use of any product or circuit, and specifically disclaims any and all liability, including without limitation special, consequential or incidental damages. "Typical" parameters which may be provided in SCILLC data sheets and/or specifications can and do vary in different applications and actual performance may vary over time. All operating parameters, including "Typicals" must be validated for each customer application by customer's technical experts. SCILLC does not convey any license under its patent rights nor the rights of others. SCILLC products are not designed, intended, or authorized for use as components in systems intended for surgical implant into the body, or other applications intended to support or sustain life, or for any other application in which the failure of the SCILLC product could create a situation where personal injury or death may occur. Should Buyer purchase or use SCILLC products for any such unintended or unauthorized application, Buyer shall indemnify and hold SCILLC and its officers, employees, subsidiaries, affiliates, and distributors harmless against all claims, costs, damages, and expenses, and reasonable attorney fees arising out of, directly or indirectly, any claim of personal injury or death associated with such unintended or unauthorized use, even if such claim alleges that SCILLC was negligent regarding the design or manufacture of the part. SCILLC is an Equal Opportunity/Affirmative Action Employer. This literature is subject to all applicable copyright laws and is not for resale in any manner.

PUBLICATION ORDERING INFORMATION

LITERATURE FULFILLMENT:
Literature Distribution Center for ON Semiconductor
P.O. Box 61312, Phoenix, Arizona 85082-1312 USA
Phone: 480-829-7710 or 800-344-3860 Toll Free USA/Canada
Fax: 480-829-7709 or 800-344-3867 Toll Free USA/Canada
Email: orderlit@onsemi.com

N. American Technical Support: 800-282-9855 Toll Free
USA/Canada

Japan: ON Semiconductor, Japan Customer Focus Center
2-9-1 Kamimeguro, Meguro-ku, Tokyo, Japan 153-0051
Phone: 81-3-5773-3850

ON Semiconductor Website: <http://onsemi.com>

Order Literature: <http://www.onsemi.com/litorder>

For additional information, please contact your local Sales Representative.